

Plaques métal - Legrand



Réf CP1201



Réf CP1202



Réf CP1203



Réf CP1204



Réf CP1601



Réf CP1602



Réf CP1603



Réf CP1701



Réf CP1702

+10
référence(s)
supplémentaire(s)

Voir les produits Legrand :
https://www.domomat.com/42_legrand

Retrouvez tous les produits Legrand
chez Domomat !

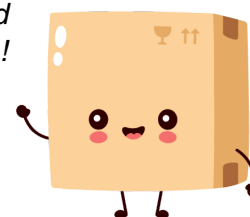

Céliane™ Plaques Métal

Références : CP1201/02/03/04/06/07/08/11/21/22/23/24
CP1601/02/03/04/06/07/08/11/21/22/23/24
CP1701/02/03/04/06/07/08/11/21/22/23/24
CP1801/02/03/04/06/07/08/09/10/11/21/22/23/24

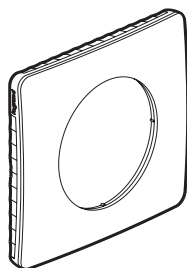

CP1201

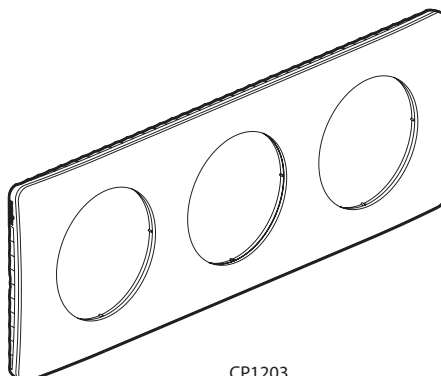

CP1203

1. USAGE

Plaques permettant l'habillage de mécanismes de 1 à 6 postes.
Montage horizontal ou vertical.
Usage en intérieur uniquement.

2. GAMME

Plaques 1 poste

	Laiton satiné Bronze satiné Aluminium satiné Acier satiné	CP1201 CP1601 CP1701 CP1801	CP1221 CP1621 CP1721 CP1821
---	--	--------------------------------------	--------------------------------------

Plaques 2 postes - Entraxe 71 mm

	Laiton satiné Bronze satiné Aluminium satiné Acier satiné	CP1202 CP1602 CP1702 CP1802	CP1222 CP1622 CP1722 CP1822
---	--	--------------------------------------	--------------------------------------

Plaques 3 postes - Entraxe 71 mm

	Laiton satiné Bronze satiné Aluminium satiné Acier satiné	CP1203 CP1603 CP1703 CP1803	CP1223 CP1623 CP1723 CP1823
---	--	--------------------------------------	--------------------------------------

Plaques 4 postes - Entraxe 71 mm

	Laiton satiné Bronze satiné Aluminium satiné Acier satiné	CP1204 CP1604 CP1704 CP1804	CP1224 CP1624 CP1724 CP1824
---	--	--------------------------------------	--------------------------------------

Plaques 2 postes - Entraxe 57 mm

	Laiton satiné Bronze satiné Aluminium satiné Acier satiné	CP1206 CP1606 CP1706 CP1806	
---	--	--------------------------------------	--

Plaques 3 postes - Entraxe 57 mm

	Laiton satiné Bronze satiné Aluminium satiné Acier satiné	CP1207 CP1607 CP1707 CP1807	
---	--	--------------------------------------	--

2. GAMME (suite)

Plaque 2 postes étendue (4/5 modules)

	Laiton satiné Bronze satiné Aluminium satiné Acier satiné	CP1208 CP1608 CP1708 CP1808
---	--	--------------------------------------

Plaque 3 postes étendue (6/8 modules)

	Laiton satiné Bronze satiné Aluminium satiné Acier satiné	CP1211 CP1611 CP1711 CP1811
---	--	--------------------------------------

Plaques 2 x 2 postes

	Acier satiné	CP1809
---	--------------	--------

Plaques 2 x 3 postes

	Acier satiné	CP1810
--	--------------	--------

3. DIMENSIONS (mm)

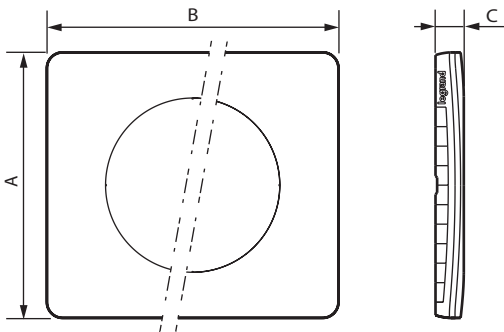

Références	A	B	C
CP1201/221/601/621/701/721/801/821	82	90	9
CP1202/222/602/622/702/722/802/822	82	161	9
CP1203/223/603/623/703/723/803/823	82	232	9
CP1204/224/604/624/704/724/804/824	82	303	9
CP1206/606/706/806	82	147	9
CP1207/607/707/807	82	204	9
CP1208/608/708/808	82	161	9
CP1211/611/711/811	82	232	9
CP1809	159	175	9
CP1810	159	246	9

4. CARACTÉRISTIQUES TECHNIQUES

■ 4.1 Caractéristiques mécaniques

Protection contre les impacts : IK 04

■ 4.2 Material characteristics

Plaque : Métal anodisé aspect satiné
 (laiton, bronze, aluminium, acier)

Sous-plaque: PC noir

Sans halogène

Résistant aux UV

Autoextinguibilité : 650° C/30 s

■ 4.3 Caractéristiques climatiques

Température de stockage : - 10° C à + 70° C

Température d'utilisation : - 5° C à + 50° C

5. ENTRETIEN

Nettoyage superficiel au chiffon.

Ne pas utiliser : acétone, dégraissant, trichloréthylène.

Tenue aux produits suivants : Hexane, alcool à brûler, eau savonneuse, produit à vitres.

Attention : Pour l'utilisation de produits d'entretien spécifiques autres, un essai préalable est nécessaire.

Aucune peinture ne doit être appliquée sur les plaques.

6. NORMES ET AGRÉMENTS

Conforme aux normes d'installation et de fabrication.

Voir e. catalogue.