

Adaptateur Paulmann - 94550

**Adaptateur Park + Light Paulmann -
24V-12V - IP67**

Réf 94550

28.76€^{TTC*}



Voir le produit :

<https://www.domomat.com/105708-adaptateur-ext-parklight-24v-12v-ip67-24v-plugshine-paulmann-94550.html>

*Le produit Adaptateur Park + Light Paulmann - 24V-12V - IP67
est en vente chez Domomat !*

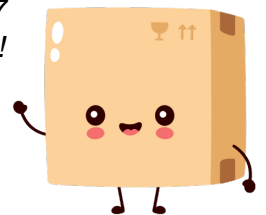



Paulmann

IP67



Info

www.paulmann.com

Paulmann Licht GmbH
Quezinger Feld 2
31832 Springe
Germany

www.paulmann.com

Art.-Nr.: 945.50



(+MA 326) PSC 07/22

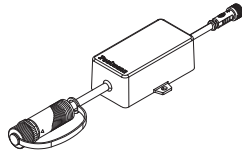

1x



1x

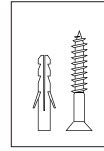

incl.

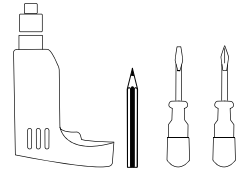

A1 A2

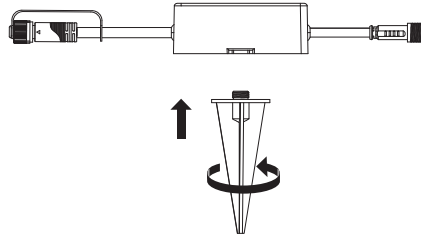

Input 24V DC

Output 12V DC

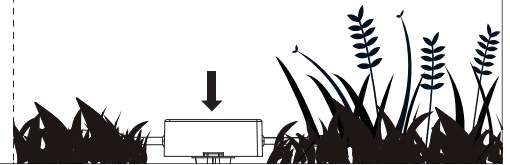
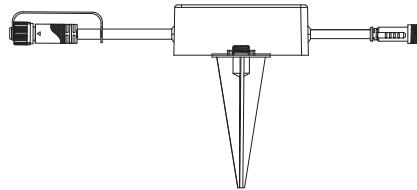

A1 A2

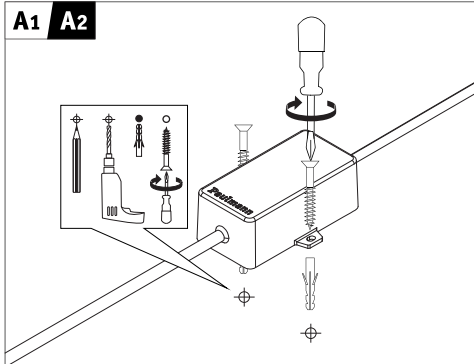

B

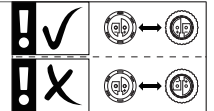
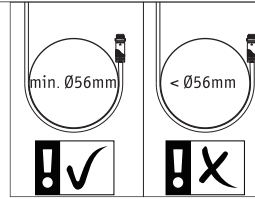

max. 50m

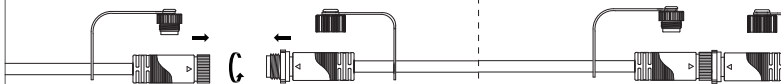

C

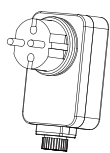

Driver
not incl.

Paulmann
Art.-Nr. 988.48

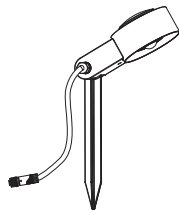

not incl.

Paulmann
Art.-Nr. 939.23

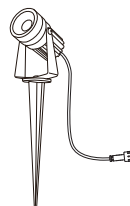

not incl.

Paulmann
Art.-Nr. 943.49

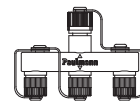

not incl.

Paulmann
Art.-Nr. 939.29

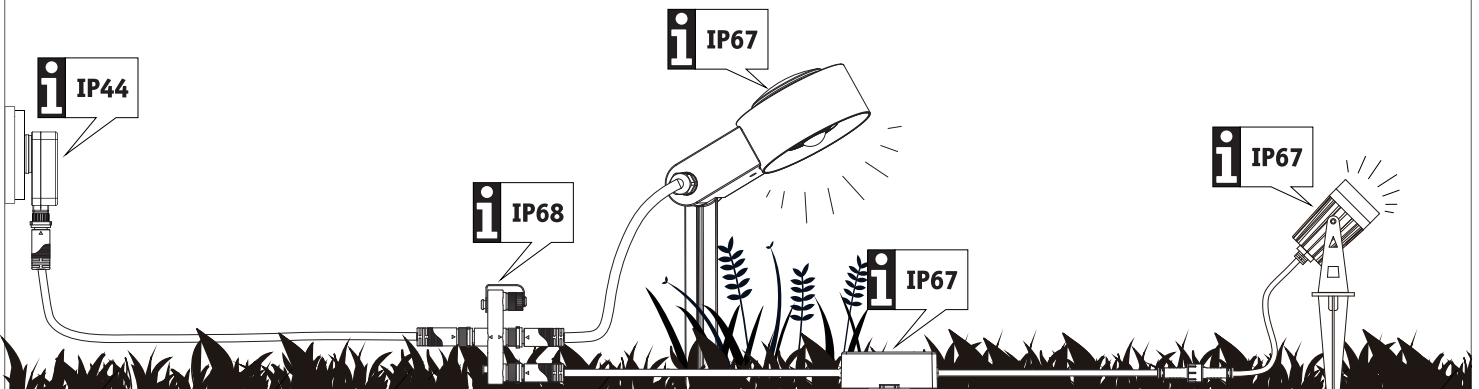

= D Altgeräte dürfen nicht in den Restmüll. Sie können bei öffentlichen Sammelstellen von Entsorgungsträgern abgegeben werden. Altbatterien und Altakkumulatoren, sowie Lampen, die zerstörungsfrei aus dem Altgerät entnommen werden können, sind vor der Abgabe an eine Erfassungsstelle von dem Altgerät zu trennen. Vertreiber sind im Rahmen von § 17 Absatz 1 und 2 Elektro zur unentgeltlichen Rücknahme dieses Produktes verpflichtet. Endnutzer von Altgeräten müssen eigenverantwortlich für die Löschung personenbezogener Daten auf den zu entsorgenden Altgeräten sorgen.
www.paulmann.com