

sarlam

CHARTRES

NT 37 869/06

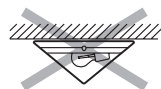
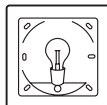
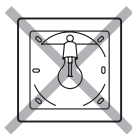
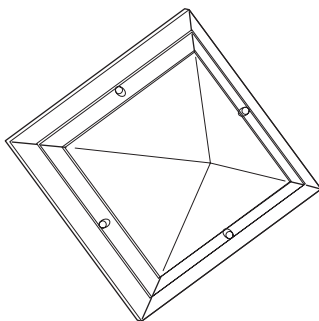

Max.

75 W

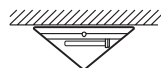
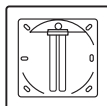
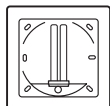

Max.

2 x 9 W - 18 W - 28 W - 38 W

1

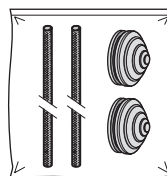
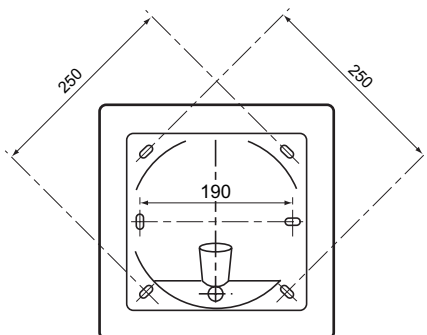

2

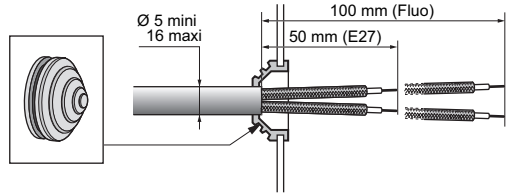
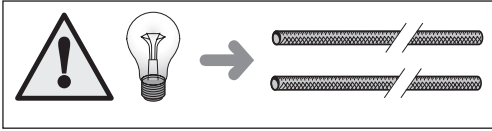

(A) E27 - 75 W Cl II □

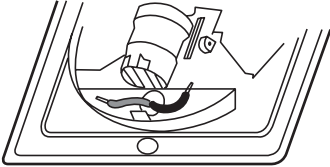

(B)

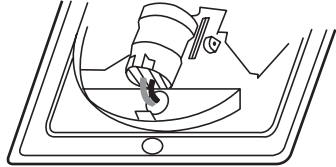

CL. I

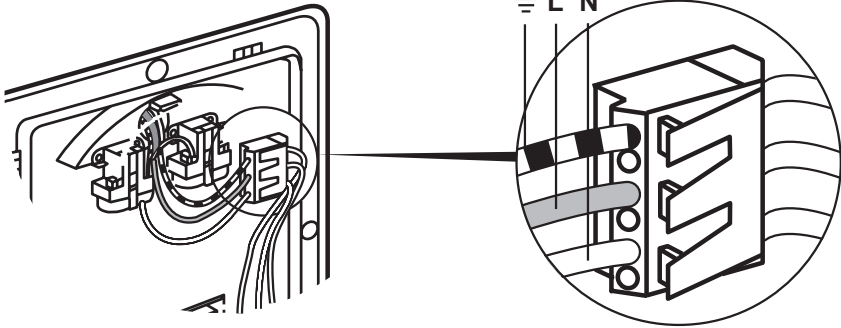

3

(A)

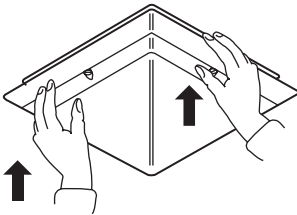

(B)

