

70917 - Paulmann



**Capteur sonore RGB Paulmann -
Pour ruban YourLED - 12V DC -
Max.60W - Noir**
Réf 70917

21.12€^{TTC*}

Voir le produit :

<https://www.domomat.com/105982-capteur-sonore-rgb-paulmann-pour-ruban-yourled-12v-dc-max60w-noir--paulmann-70917.html>

*Le produit Capteur sonore RGB Paulmann - Pour ruban YourLED - 12V DC - Max.60W -
Noir
est en vente chez Domomat !*

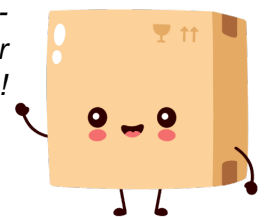



Paulmann

IP20



Info

www.paulmann.com

Paulmann Licht GmbH
Quezinger Feld 2
31832 Springe
Germany

www.paulmann.com

Art.-Nr.: 709.17



PLIR 09/20

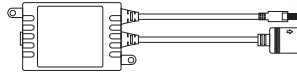

1x



1x



Li-Ion

1x

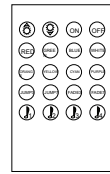

1x



1x

A

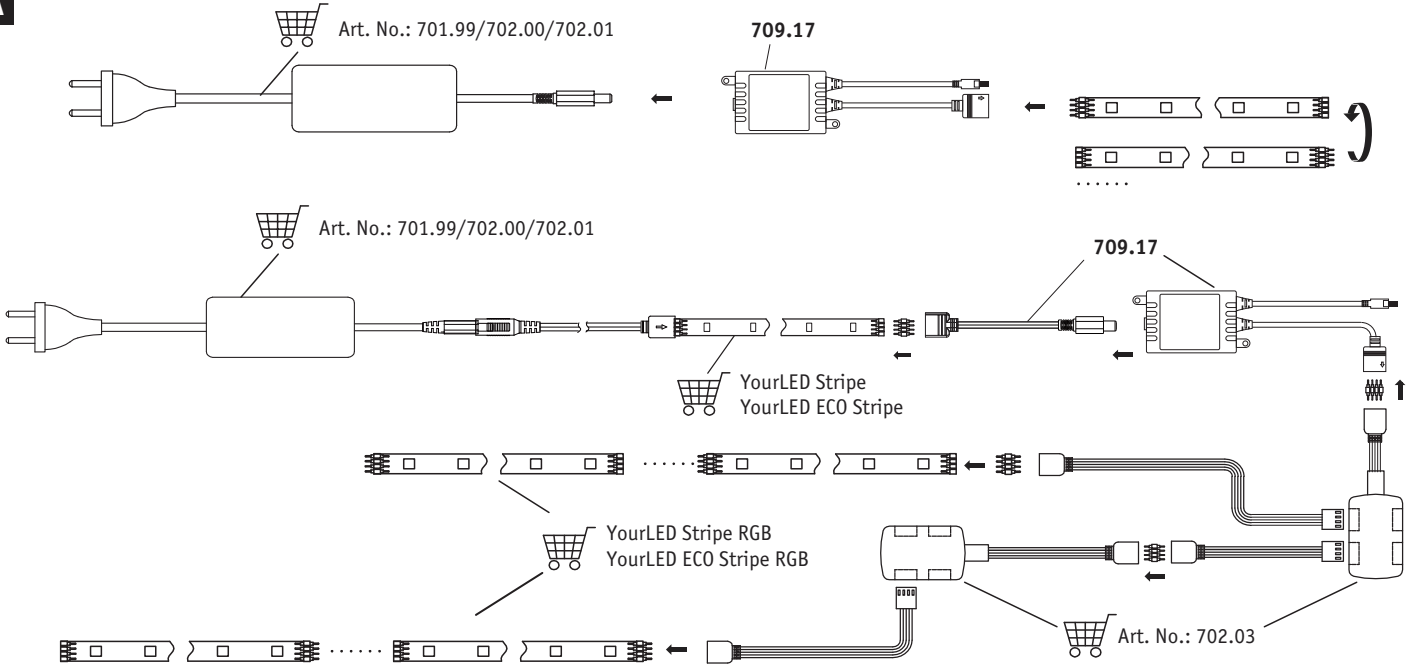

B

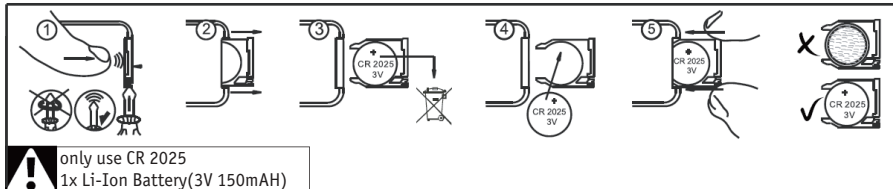
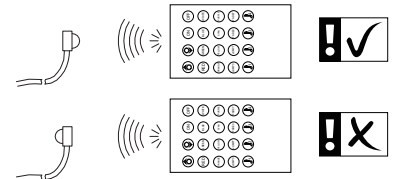
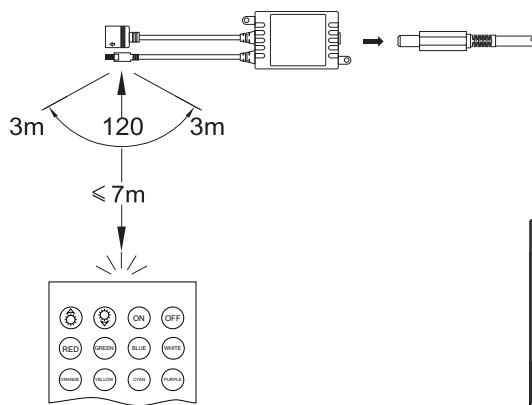

C

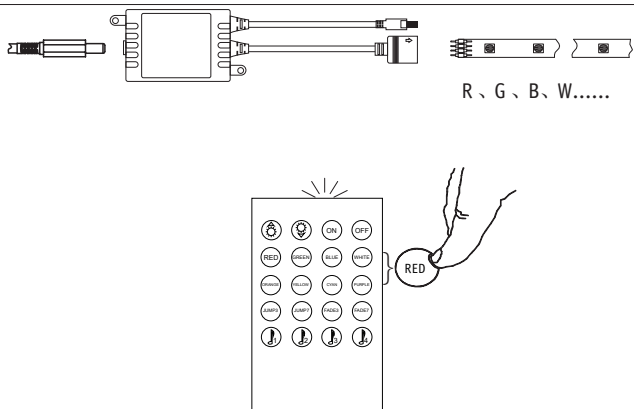

D

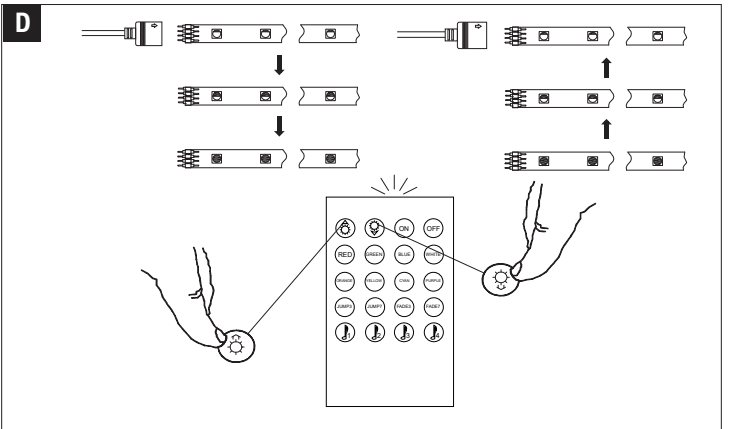

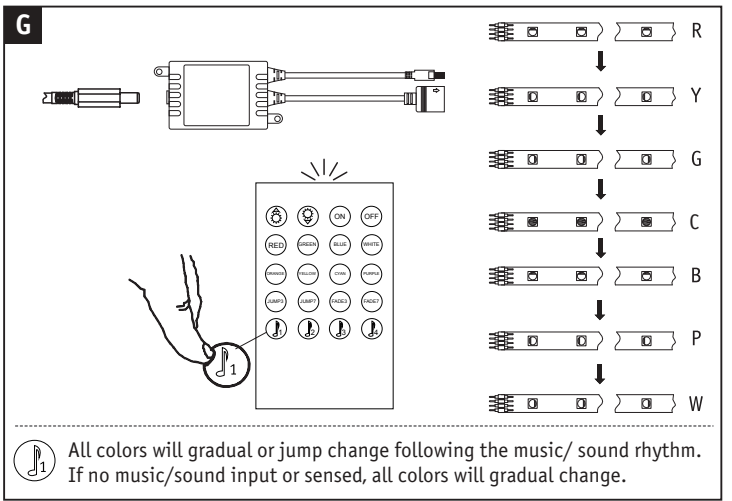
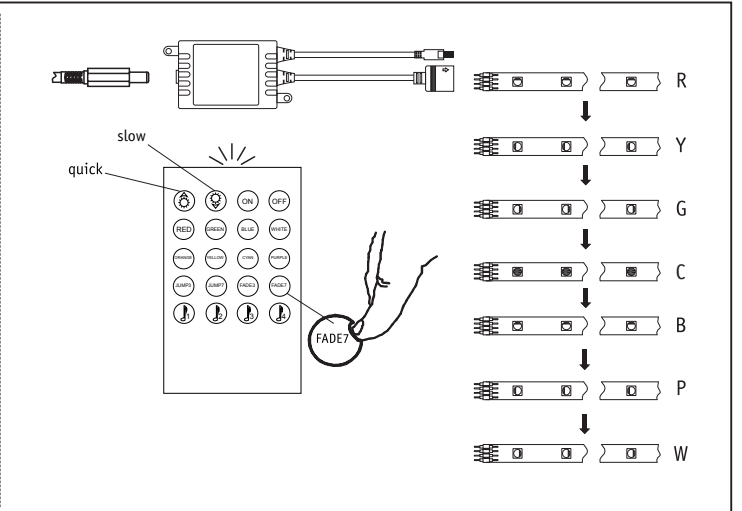
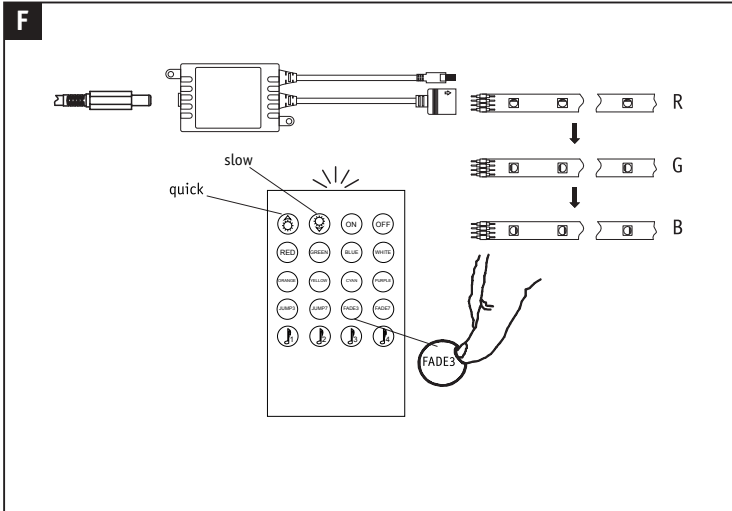
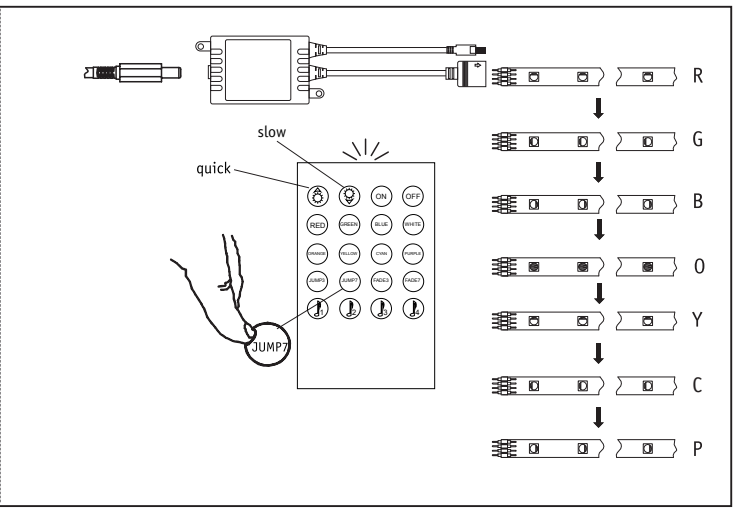
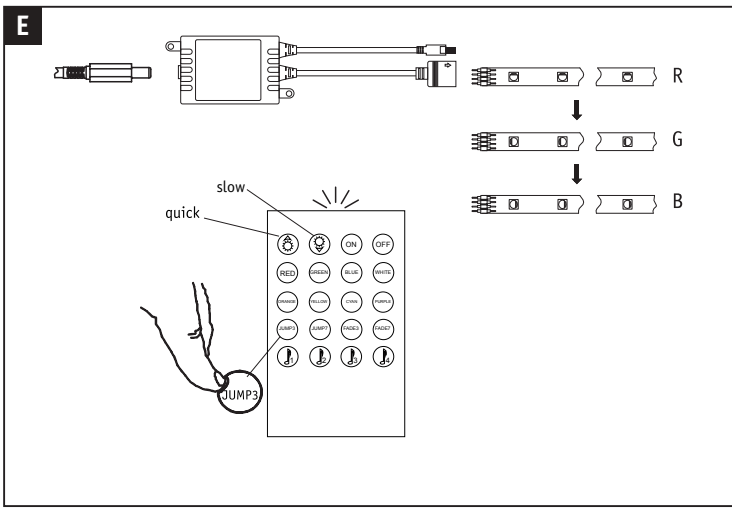

J1 All colors will gradual or jump change following the music/ sound rhythm. If no music/sound input or sensed, all colors will gradual change.

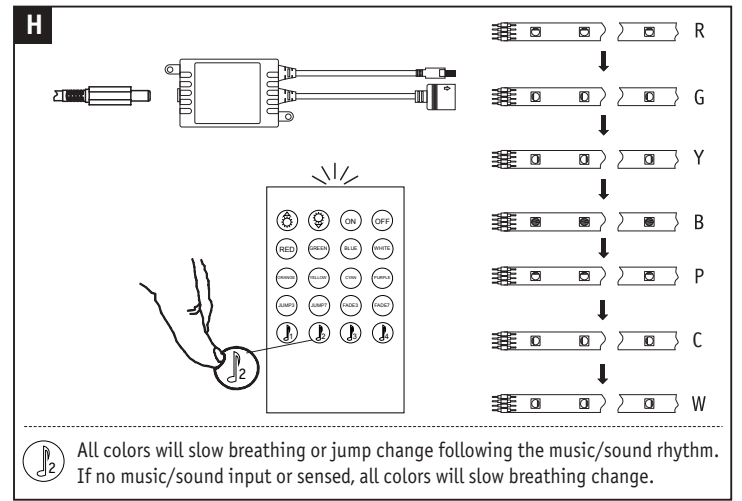

J2 All colors will slow breathing or jump change following the music/sound rhythm. If no music/sound input or sensed, all colors will slow breathing change.

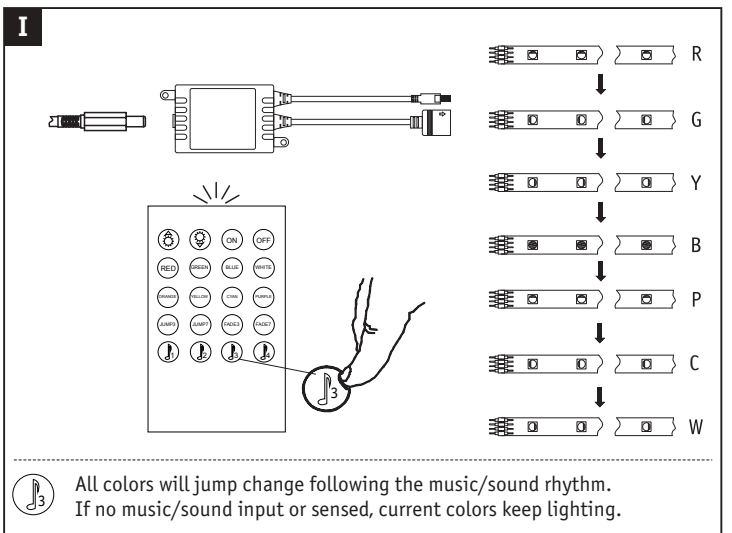

J3 All colors will jump change following the music/sound rhythm. If no music/sound input or sensed, current colors keep lighting.

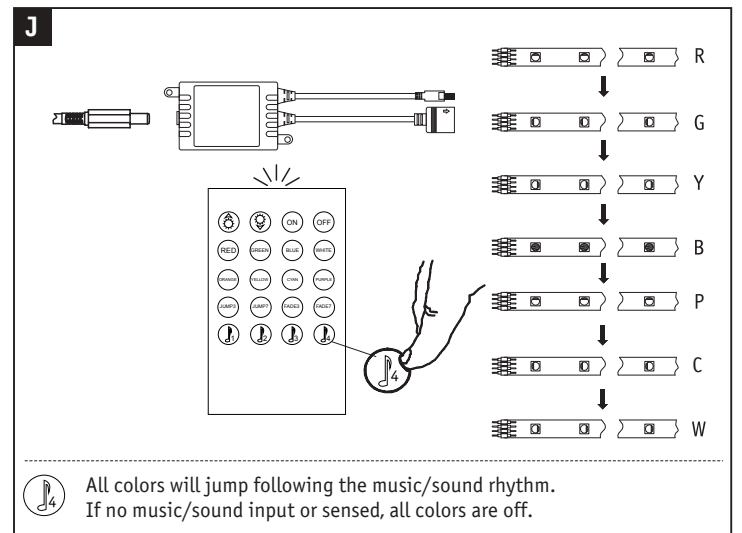

J4 All colors will jump following the music/sound rhythm. If no music/sound input or sensed, all colors are off.